

# Code•Master™ Factory Sealed Strobe Luminaires

## Explosionproof, Dust-Ignitionproof

### NEC:

Class I, Division 1 and 2, Groups C, D  
Class I, Division 2, Groups A, B  
Class II, Division 1 and 2, Groups E, F, G  
Class III  
NEMA 3R, 4X

### NEC:

Suitable for Wet Locations  
Marine Outside Type (Saltwater)

### Applications

- Code•Master Explosionproof Strobe fixtures are designed to provide safe operation in the presence of hazardous gases, vapors or dusts, defined by the National Electrical Code as Class I, Groups C and D; and Class II, Groups E, F and G.
- For use in hazardous locations such as plants where plastics, paints, thinners and petrochemicals are manufactured.
- Also used in areas where audible signals cannot be heard, to warn of unsafe conditions and for other communication needs.

### Features

- Fixtures operate safely in high ambient temperatures.
- Minimum operating temperature is -25 °C (-13 °F).
- Available for fire alarm hearing impaired.
- 65 flashes per minute.
- Fixtures are complete with lamp.
- Patented “wireless” design. Threading of fixture unit onto mounting hood makes electrical connection. The only wiring required is attaching two wires to connection block in mounting hood.
- Connection block is easily wired: (a) loosen two screws, (b) make wire connections; and (c) re-position connection block.
- Safe, easy servicing without disconnecting any wiring. “Wireless” fixture unit threads off mounting hood for convenient servicing or for immediate replacement with a “stand by” unit.
- Acme double lead threads speed installation and fixture removal from mounting hood. Only half as many turns are required as for single lead threads. The threads do not stick or gall, eliminating problems often encountered with single lead threads during fixture unit removal.
- All threaded joints are flame-tight.
- Factory installed lens available in five colors: red, amber, blue, green and clear (factory installed).
- Factory sealed. External seals are not required.
- Heat- and impact-resistant globes have smooth dust-resistant exterior.
- Fixture is suitable for mounting globe up or globe down utilizing pendant, ceiling or wall bracket type mounts.
- Optional guards protect globes from damage.

### Standard Materials

- Fixture housing, mounting hoods and guards: copperfree (4/10 of 1% max.) aluminum
- Globes: prismatic glass
- Screws: Stainless steel (3)

### Standard Finishes

- Fixture housing, guards and mounting hoods: epoxy power coat finish, electrostatically applied for complete, uniform corrosion protection

### NEC Certifications and Compliances

- UL Listed: E212210
- UL Standard: 1203
- UL Standard: 1638 Visual Signaling Appliances
- UL Standard: 1971 Visual Signaling Equipment has been investigated for fire protective signaling services to alert hearing impaired persons. This signaling equipment is intended to be used in conjunction with Listed compatible units and devices. Visual signaling equipment Listed in this category is intended to be used in the “Public Operating Mode” as defined in NFPA 72



Fixture (shown with optional guard) are suitable for mounting in any position including globe up or globe down utilizing pendant, ceiling or wall-bracket type mounts.

Appleton®

VISUAL SIGNAL: NEC/CEC EXPLOSIONPROOF

# Code•Master™ Factory Sealed Strobe Luminaires

Explosionproof, Dust-Ignitionproof

**NEC:**  
 Class I, Division 1 and 2, Groups C, D  
 Class I, Division 2, Groups A, B  
 Class II, Division 1 and 2, Groups E, F, G  
 Class III  
 NEMA 3R, 4X

**NEC:**  
 Suitable for Wet Locations  
 Marine Outside Type (Saltwater)

## Ordering Information

Order using catalog numbering guide below or select catalog number from tables on following pages.

## Catalog Numbering Guide

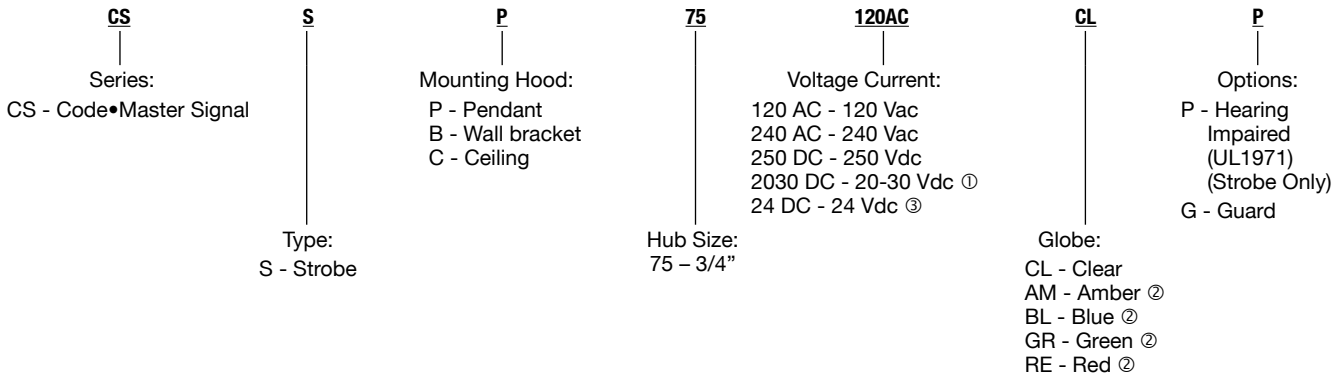

## Thermal Suitability of Code-Master Strobe Fixture

Ambient Temp. °C (°F)	Class I, Division 1 and 2 Groups C and D	Class I, Division 2 Groups A and B	Class II, Division 1 and 2 Class III
40 (104)	T6	T2B	T4A
55 (131)	T6	T2B	T4A
65 (149)	T6	T2A	T4

## Operating Temperatures

"T" Numbers Represent the Maximum Internal Temperature for Class I, Division 2 Locations; Maximum Surface Temperature for Class I, Division 1 Locations; and Maximum Surface Temperature Under Dust Blanket for Class II, Division 1 Locations.

"T" Number	T1	350	325	T2	T2A	T2B	T2C	T2D	T3	T3A	T3B	T3C	T4	T4A	T5	T6
Temp. Range (°C)	351-450	326-350	301-325	281-300	261-280	231-260	216-230	201-215	181-200	166-180	161-165	136-160	121-135	101-120	86-100	85
Temp. Range (°F)	664-842	619-662	574-617	538-572	502-536	448-500	421-446	394-419	358-392	331-356	322-329	277-320	250-275	214-248	187-212	185

NOTE: The maximum operating temperature of the fixture must not exceed the ignition temperature of the gas, vapor or dust to be encountered per the National Electrical Code.

① UL1971: Hearing-Impaired Strobe Only

② Not for use with UL1971 Strobe







③ Diode Polarized (Current limiter supplied as standard).

# Code•Master™ Factory Sealed Strobe Luminaires

## Explosionproof, Dust-Ignitionproof

**NEC:**  
 Class I, Division 1 and 2, Groups C, D  
 Class I, Division 2, Groups A, B  
 Class II, Division 1 and 2, Groups E, F, G  
 Class III  
 NEMA 3R, 4X

**NEC:**  
 Suitable for Wet Locations  
 Marine Outside Type (Saltwater)

Standard Strobes		Volts	Catalog Number ①③
<b>Pendant — One Hub 3/4" NPT, Rigid Conduit</b>			
		120 Vac	CSSP75120ACCL
		240 Vac	CSSP75240ACCL
		250 Vdc	CSSP75250DCCL
		24 Vdc	CSSP7524DCCL ②
<b>Ceiling — Four Hubs 3/4" NPT, Three Close-Up Plugs, Rigid Conduit</b>			
		120 Vac	CSSC75120ACCL
		240 Vac	CSSC75240ACCL
		250 Vdc	CSSC75250DCCL
		24 Vdc	CSSC7524DCCL ②
<b>Bracket — Four Hubs 3/4" NPT, Three Close-Up Plugs, Rigid Conduit</b>			
		120 Vac	CSSB75120ACCL
		240 Vac	CSSB75240ACCL
		250 Vdc	CSSB75250DCCL
		24 Vdc	CSSB7524DCCL ②
<b>Fixture Unit Only — Less Mounting Hood</b>			
		120 Vac	CSST120ACCL
	10.36 kg (4.7 lb)	240 Vac	CSST240ACCL
		250 Vdc	CSST250DCCL
		24 Vdc	CSST24DCCL ②
	<b>Weight kg (lb)</b>	<b>Hub Size (Inches)</b>	<b>Catalog Number</b>
<b>Pendant Mounting Hood — One Hub 3/4" NPT, Rigid Conduit</b>			
	9.0 (19.84)	3/4	CAP-75
<b>Ceiling Mounting Hood — Four Hubs 3/4" NPT, Three Close-Up Plugs, Rigid Conduit</b>			
	1.8 (3.97)	3/4	CAC-75
<b>Bracket Mounting Hood — Four Hubs 3/4" NPT, Three Close-Up Plugs, Rigid Conduit</b>			
	2.7 (5.95)	3/4	CALB-75

① Add -G suffix for optional guard.

② Diode polarized (current limiter supplied as standard).

③ Catalog numbers shown are supplied with clear lens. To order colored lens, replace last digits of catalog number CL with AM for amber; BL for blue; GR for green; and RE for red.







# Code•Master™ Factory Sealed Strobe Luminaires

Explosionproof, Dust-Ignitionproof

**NEC:**  
 Class I, Division 1 and 2, Groups C, D  
 Class I, Division 2, Groups A, B  
 Class II, Division 1 and 2, Groups E, F, G  
 Class III  
 NEMA 3R, 4X

**NEC:**  
 Suitable for Wet Locations  
 Marine Outside Type (Saltwater)

## Strobes for the Hearing Impaired

	Type Mounting	Volts	Catalog Number — UL1971: Hearing-Impaired ①
<b>Pendant — One Hub 3/4" NPT, Rigid Conduit</b>			
		20-30 Vdc	CSSP752030DCCLP
<b>Ceiling — Four Hubs 3/4" NPT, Three Close-Up Plugs, Rigid Conduit</b>			
		20-30 Vdc	CSSC752030DCCLP
<b>Fixture Unit Only — Less Mounting Hood</b>			
		20-30 Vdc	CSSB752030DCCLP
<b>Fixture Unit Only — Less Mounting Hood</b>			
	4.7 kg (10.36 lb)	20-30 Vdc	CSST2030PDCCL
	<b>Weight kg (lb)</b>	<b>Hub Size (Inches)</b>	<b>Catalog Number — UL1971: Hearing-Impaired</b>
<b>Pendant Mounting Hood — One Hub 3/4" NPT, Rigid Conduit</b>			
	9.0 (19.84)	3/4	CAP-751971
<b>Ceiling Mounting Hood — Four Hubs 3/4" NPT, Three Close-Up Plugs, Rigid Conduit</b>			
	1.8 (3.97)	3/4	CAC-751971
<b>Bracket Mounting Hood — Four Hubs 3/4" NPT, Three Close-Up Plugs, Rigid Conduit</b>			
	2.7 (5.95)	3/4	CALB-751971



① Only clear globes are available for UL1971 applications.

# Code•Master™ Factory Sealed Strobe Luminaires

## Explosionproof, Dust-Ignitionproof

**NEC:**  
 Class I, Division 1 and 2, Groups C, D  
 Class I, Division 2, Groups A, B  
 Class II, Division 1 and 2, Groups E, F, G  
 Class III  
 NEMA 3R, 4X

**NEC:**  
 Suitable for Wet Locations  
 Marine Outside Type (Saltwater)

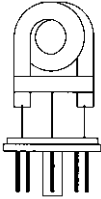
Description		Weight kg (lb)	Catalog Number	
<b>Optional Aluminum Guard</b>				
		0.5 (1.10)	<b>CJGU-15</b>	
<b>Replacement Connection Block — Standard</b>				
	For Non-Hearing-Impaired CodeMaster Fixtures	0.2 (0.44)	<b>VPT-7</b>	
<b>Replacement Connection Block — UL1971: Hearing-Impaired</b>				
	For Code-Master Fixtures for the Hearing Impaired	0.2 (0.44)	<b>VPT-7P</b>	
<b>Replacement Lamps</b>				
Fixture Type	Lamp Type	Voltage	Base Type	Catalog Number
 <b>Strobe</b>	Xenon	All	Octal Socket	<b>S865</b>

 **Appleton**

VISUAL SIGNAL: NEC/CEC EXPLOSIONPROOF

# Code•Master™ Factory Sealed Strobe Luminaires

## Explosionproof, Dust-Ignitionproof

**NEC:**  
 Class I, Division 1 and 2, Groups C, D  
 Class I, Division 2, Groups A, B  
 Class II, Division 1 and 2, Groups E, F, G  
 Class III  
 NEMA 3R, 4X

**NEC:**  
 Suitable for Wet Locations  
 Marine Outside Type (Saltwater)

**Pendant**  
 One Hub, 3/4" NPT  
**CAP75 or CAP75-1971**



**Ceiling**  
 Four Hubs, Three Close-Up Plugs, 3/4" NPT  
**CAC75 or CAC75-1971**



**Bracket**  
 Four Hubs, Three Close-Up Plugs, 3/4" NPT  
**CALB75 or CALB75-1971**



**Code•Master Incandescent Fixture Unit  
 CSST**



**Optional Aluminum Guard  
 CJGU-15**

Appleton®

VISUAL SIGNAL: NEC/CEC EXPLOSIONPROOF

### Dimensions in Millimeters (Inches)

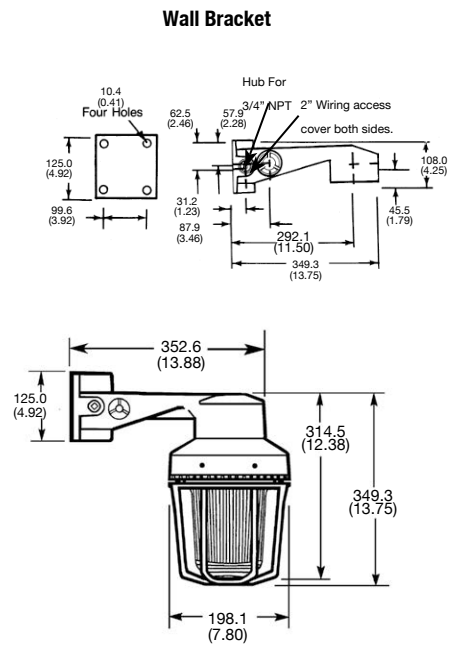
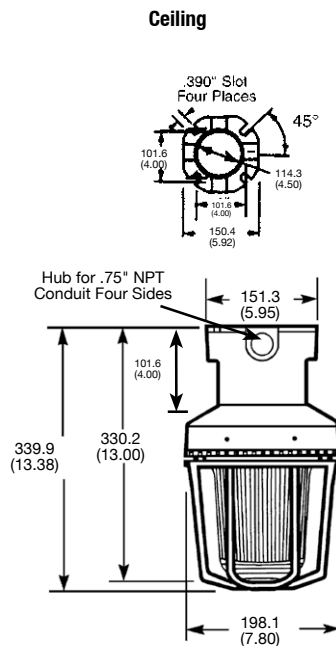
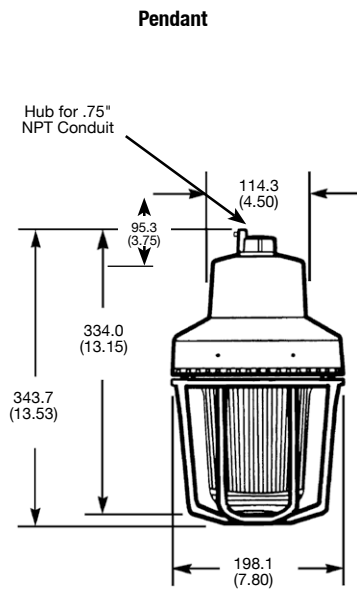

① UL1971: Hearing-Impaired Strobe Only  
 ② Diode polarized (current limiter supplied as standard).